

1. The five pieces shown below can be arranged to form four of the five figures shown in the choices. Which figure cannot be formed?

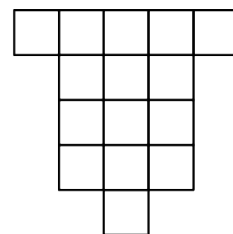
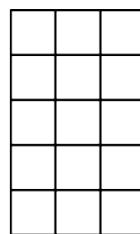
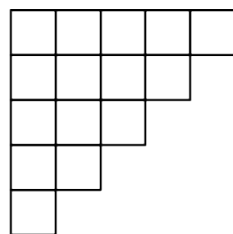
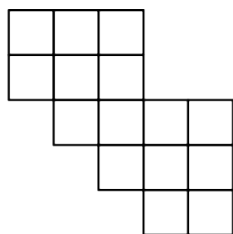
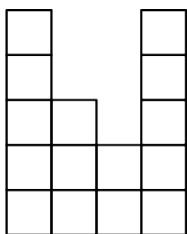
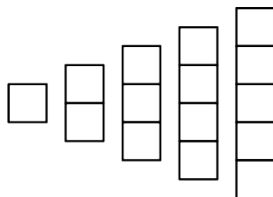

(A)

(B)

(C)

(D)

(E)

2. A sequence of numbers starts with 1, 2, and 3. The fourth number of the sequence is the sum of the previous three numbers in the sequence:  $1 + 2 + 3 = 6$ . In the same way, every number after the fourth is the sum of the previous three numbers. What is the eighth number in the sequence?
3. Steve's empty swimming pool will hold 24,000 gallons of water when full. It will be filled by 4 hoses, each of which supplies 2.5 gallons of water per minute. How many hours will it take to fill Steve's pool?

4. Austin and Temple are 50 miles apart along Interstate 35. Bonnie drove from Austin to her daughter's house in Temple, averaging 60 miles per hour. Leaving the car with her daughter, Bonnie rode a bus back to Austin along the same route and averaged 40 miles per hour on the return trip. What was the average speed for the round trip, in miles per hour?
5. The triangular plot of ACD lies between Aspen Road, Brown Road and a railroad. Main Street runs east and west, and the railroad runs north and south. The numbers in the diagram indicate distances in miles. The width of the railroad track can be ignored. How many square miles are in the plot of land ACD?

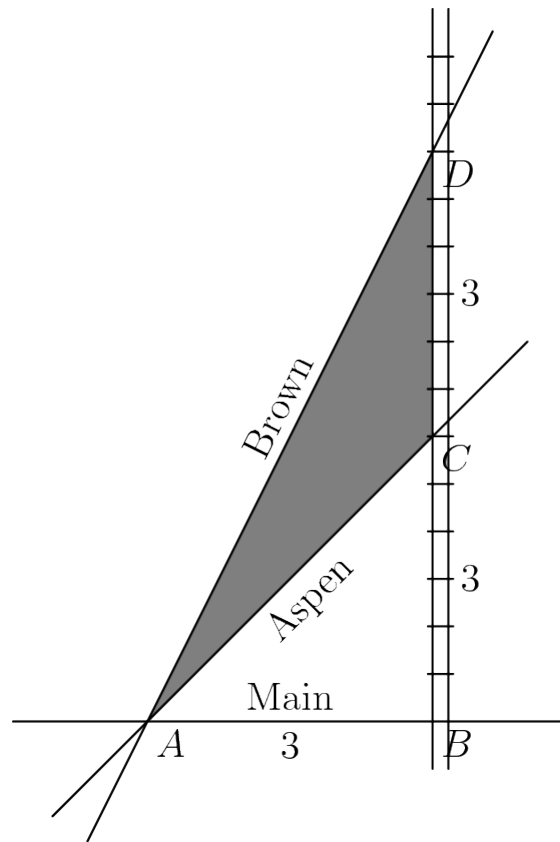

6. The length of a rectangle is increased by 10% and the width is decreased by 10%. What percent of the old area is the new area?
7. Construct a square on one side of an equilateral triangle. On one non-adjacent side of the square, construct a regular pentagon, as shown. On a non-adjacent side of the pentagon, construct a hexagon. Continue to construct regular polygons in the same way, until you construct an octagon. How many sides does the resulting polygon have?

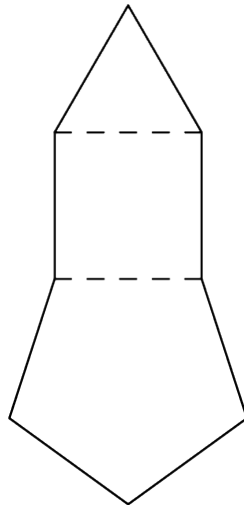

8. On a checkerboard composed of 64 unit squares, what is the probability that a randomly chosen unit square does not touch the outer edge of the board?

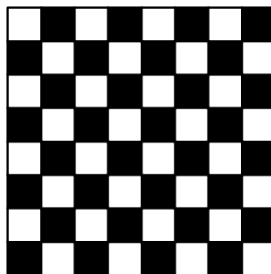

9. The Amaco Middle School bookstore sells pencils costing a whole number of cents. Some seventh graders each bought a pencil, paying a total of \$1.43. Some of the 30 sixth graders each bought a pencil, and they paid a total of \$1.95. How many more sixth graders than seventh graders bought a pencil?
10. A three-digit integer contains one of each of the digits 1, 3, and 5. What is the probability that the integer is divisible by 5?
11. A recipe that makes 5 servings of hot chocolate requires 2 squares of chocolate,  $\frac{1}{4}$  cup sugar, 1 cup water and 4 cups milk. Jordan has 5 squares of chocolate, 2 cups of sugar, lots of water and 7 cups of milk. If she maintains the same ratio of ingredients, what is the greatest number of servings of hot chocolate she can make?
12. How many 3-digit positive integers have digits whose product equals 24?
13. The positive integers  $x$  and  $y$  are the two smallest positive integers for which the product of 360 and  $x$  is a square and the product of 360 and  $y$  is a cube. What is the sum of  $x$  and  $y$ ?
14. The diagram represents a 7-foot-by-7-foot floor that is tiled with 1-square-foot black tiles and white tiles. Notice that the corners have white tiles. If a 15-foot-by-15-foot floor is to be tiled in the same manner, how many white tiles will be needed?

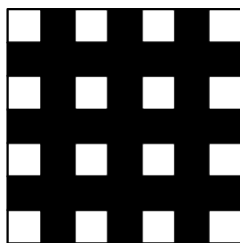

15. Two angles of an isosceles triangle measure  $70^\circ$  and  $x^\circ$ . What is the sum of the three possible values of  $x$ ?
16. How many non-congruent triangles have vertices at three of the eight points in the array shown below?

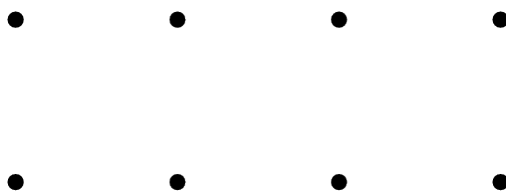

17. Andy and Bethany have a rectangular array of numbers greater than 0 with 40 rows and 75 columns. Andy adds the numbers in each row. The average of his 40 sums is  $A$ . Bethany adds the numbers in each column. The average of her 75 sums is  $B$ . What is the value of  $\frac{A}{B}$ ?
18. How many whole numbers between 1 and 1000 do not contain the digit 1?
19. On the last day of school, Mrs. Awesome gave jelly beans to her class. She gave each boy as many jelly beans as there were boys in the class. She gave each girl as many jelly beans as there were girls in the class. She brought 400 jelly beans, and when she finished, she had six jelly beans left. There were two more boys than girls in her class. How many students were in her class?

20. The letters  $A$ ,  $B$ ,  $C$  and  $D$  represent digits. If 
$$\begin{array}{r} A \ B \\ + \ C \ A \\ \hline D \ A \end{array}$$
 and

$$\begin{array}{r} A \ B \\ - \ C \ A \\ \hline A \end{array},$$

what digit does  $D$  represent?

21. A one-cubic-foot cube is cut into four pieces by three cuts parallel to the top face of the cube. The first cut is  $1/2$  foot from the top face. The second cut is  $1/3$  foot below the first cut, and the third cut is  $1/17$  foot below the second cut. From the top to the bottom the pieces are labeled A, B, C, and D. The pieces are then glued together end to end as shown in the second diagram. What is the total surface area of this solid in square feet?

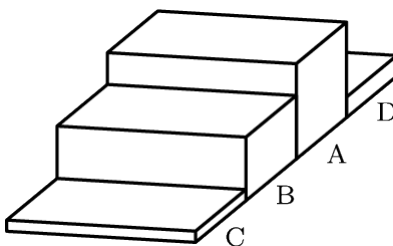
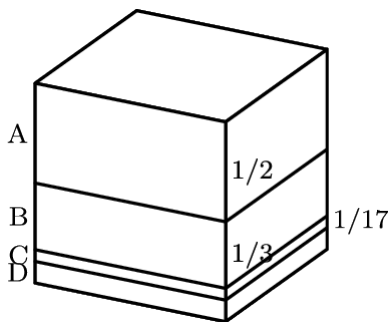

22. Let  $\{a_k\}$  be a sequence of integers such that  $a_1 = 1$  and  $a_{m+n} = a_m + a_n + mn$ , for all positive integers  $m$  and  $n$ . Then  $a_{12}$  is
23. When 15 is appended to a list of integers, the mean is increased by 2. When 1 is appended to the enlarged list, the mean of the enlarged list is decreased by 1. How many integers were in the original list?
24. What is the difference between the sum of the first 2003 even counting numbers and the sum of the first 2003 odd counting numbers?

- 
25. Members of the Rockham Soccer League buy socks and T-shirts. Socks cost \$4 per pair and each T-shirt costs \$5 more than a pair of socks. Each member needs one pair of socks and a shirt for home games and another pair of socks and a shirt for away games. If the total cost is \$2366, how many members are in the League?
26. A solid box is 15 cm by 10 cm by 8 cm. A new solid is formed by removing a cube 3 cm on a side from each corner of this box. What percent of the original volume is removed?
27. It takes Mary 30 minutes to walk uphill 1 km from her home to school, but it takes her only 10 minutes to walk from school to her home along the same route. What is her average speed, in km/hr, for the round trip?
28. Let  $d$  and  $e$  denote the solutions of  $2x^2 + 3x - 5 = 0$ . What is the value of  $(d - 1)(e - 1)$ ?
29. How many non-congruent triangles with perimeter 7 have integer side lengths?
30. What is the probability that a randomly drawn positive factor of 60 is less than 7?
31. The sum of the two 5-digit numbers  $AMC10$  and  $AMC12$  is 123422. What is  $A + M + C$ ?

32. A point  $(x, y)$  is randomly picked from inside the rectangle with vertices  $(0, 0)$ ,  $(4, 0)$ ,  $(4, 1)$ , and  $(0, 1)$ . What is the probability that  $x < y$ ?
33. The sum of three numbers is 20. The first is four times the sum of the other two. The second is seven times the third. What is the product of all three?
34. Let  $n$  be the largest integer that is the product of exactly 3 distinct prime numbers  $d$ ,  $e$ , and  $10d + e$ , where  $d$  and  $e$  are single digits. What is the sum of the digits of  $n$ ?
35. What is the probability that an integer in the set  $\{1, 2, 3, \dots, 100\}$  is divisible by 2 and not divisible by 3?
36. What is the units digit of  $13^{2003}$ ?
37. This item replaces the usual puzzle. You will see that it is even more challenging. A man goes into a convenience store, picks out four items, and goes to check out. The cashier tells him that her cash register is broken, and she will use her calculator. She proceeds to process the four amounts, and says, “that will be \$7.11.” “Wait a minute”, he protests, “you multiplied the prices together”. She promptly repeats the calculation, this time adding the four amounts, and exclaims, “There, you owe \$7.11, just as I said.” (There is no tax on food in this state.) What are the four prices? In the problems below, let us agree that a set of positive real numbers is called a *7-11 set* if the sum of its elements is the same as their product and the problem is called the 7 – 11 problem even though the common value is not \$7.11. That common number is denoted  $T$ . So the problem above is the four-item problem with  $T = 7.11$ .